



MINISTRIES

SATELLITE CHURCH SERVICE MANUAL

*Creating a Successful Service
in Your Community*

**LOVIN' LIFE LEARNING CENTER
4 West 43rd Street
New York, NY 10036**

MAY 23, 2010

What's in this manual?

This manual is focused on the “Inspire” component of Church, which is Sunday Service. These two hours contain elements that, when put together and done effectively, can create a highly inspirational service that ultimately prepares each guest in the audience to receive our National Pastor’s message.



CONTENTS

WHAT'S IN THIS MANUAL?
3

GET READY TO LOVE LIFE!
5

GENERAL CRITERIA
8

GUEST SERVICES TEAM
11

PRODUCTION
22

TECH TEAM
35

CREATIVE TEAM
44

EMPOWER!
48

CONNECT!
49

CONTRIBUTE!
51

Get ready to LOVE LIFE!

Lovin' Life Ministries has four ways of creating a ministry that allows every individual to grow in their faith each and every week. These areas are:

INSPIRE EMPOWER CONNECT CONTRIBUTE

Lovin' Life Ministries understands that everyone is on a journey, and has a unique experience. That is why Rev. In Jin Moon has developed a service and a ministry that offers every person an opportunity to grow, no matter where they are. The growth process begins with Inspire! This is Sunday Service. It is the first step to becoming a part of the church family. It is a time to receive and to be spiritually nourished. The service experience itself is about two hours long on Sunday, but Church actually happens each and every day, all the time! This is where "Empower," "Connect," and "Contribute" become important, as they are the building blocks of a ministry that is built around the Sunday Service. This is not to say that all four areas of growth are not also experienced at church, because they are. Nevertheless, much happens outside of Sunday Service during the week. This is why the local congregation and local pastors are a critical part of Lovin' Life Ministries.

INSPIRE Rev. In Jin Moon inspires us by delivering a message centered on God and True Parents, and bringing us a connection to Heaven. Sunday Service also includes carefully selected and uplifting worship music, scripture readings, and its own unique national "notice board."

EMPOWER We are empowered to grow spiritually by continually learning and attending classes, seminars, and retreats throughout our life journey.

CONNECT Our community grows in heart through building strong relationships with one another and by demonstrating our love for our brothers and sisters. We encourage each other to grow and succeed in life by connecting through small groups.

CONTRIBUTE We give back to both our church community and the world by joining volunteer teams, donating and by tithing.

Church is INSPIRING!

Why do we have Sunday Service? It's our connection to our Heavenly Parent. It's the way we receive spiritual inspiration and enrichment for the week. It's a place to recharge and get connected to our National Pastor In Jin Moon. The model of Lovin' Life Ministries has four areas of growth: Inspire, Empower, Connect, and Contribute. Sunday Service fulfills the core element which is INSPIRE. Why? Because it is through our National Pastor that we are inspired and uplifted each week, and it is the most effective way to reach our new guests!

In fact, Sunday Service should be treated as a very open and accessible "Gateway" for new guests to come and experience church, and leave inspired. While Sunday Service is a time for current members to be uplifted each week, the service must also take the approach of a "seeker service." This means that service should attract new guests who are seeking and looking for a place to belong.

***Service should be:
Welcoming! Comfortable!
Inspiring! Fun!***

Sunday Service is the time when we come together as a church family, so naturally we enjoy spending time with one another. Engaging with one another in a loving and warm way is also a tool, believe it or not, to creating a successful service. New guests are ultimately searching for a home. They are looking for a community where they can feel they belong. They may be inspired by the message, but if they are not able to connect to the community, then they may not return. Seeing a community they can relate to and connect with is very important.

A QUALITY EXPERIENCE IN EVERY LOCATION!



Although Lovin' Life at the Manhattan Center may be much larger than in your location, your Sunday Service can express the same heart and touch people's lives in much the same way. The guest's experience is rooted in God's love, conveyed through Rev. In Jin Moon's message and the personal care and love expressed by our members. By striving for a quality production, even the smallest community can experience a Sunday Service that is as moving and dynamic as Lovin' Life at the Manhattan Center. And, by doing so, small communities will grow and become large communities!

GENERAL CRITERIA

What are the qualities of a successful Sunday Service?

Every action tells a story! So much of who we are and what we value is expressed through the Sunday Service. We need to make sure that the right values are shining through! Does your Sunday Service mirror our value of professionalism or does it show disorganization! Is the atmosphere we are creating encouraging; are we using positive words? Most importantly is the environment inclusive? Could you bring a friend and they would feel like they belong? Create a conversation with your ministry team and identify the qualities of a successful Sunday Service and discuss where you see those qualities and values expressed.

- Welcoming environment
- Professionalism
- Authenticity
- Team effort
- Inclusive atmosphere
- "Seeker" sensitive
- Encouraging
- United vision
- Consistency
- Prayerful attitude
- Brings awareness about activities in the community
- Thinks GLOBAL and acts LOCAL!



What are the elements that support a Sunday Service?

Excellence is in the details! The best way to think of all the elements that are involved in creating a great experience for your guests and soon to be members is to imagine them coming to Sunday Service and thinking about what they would experience each step of the way. What signage would tell them they had arrived at the right location? How would they be welcomed? What is the quality of the sound and video? Were the transitions from one part of the Service to the next smooth and natural? Was there child care? You can use the checklist below to help you consider all the elements that need to be addressed and taken care of.

- Welcoming environment
- Signage and graphics
- Parking accommodations
- Effective lighting
- Worship music
- Quality sound and video equipment
- Broadcast message from pastor is clear and displayed on good screen
- Tithe collection locally
- Prayer after message by a guest religious leader: Rabbi, Imam, Priest or Minister
- Local video announcements after service
- Local guest service team
- Local media team
- Local creative team
- Local youth crew (ministry)
- Resources and materials
- Local education team

Who makes Sunday Service happen?

Sunday Service is a team effort. If you look down the list of the different roles you will see that many people are involved in creating an excellent service! This is great because it provides lots of opportunities for people to invest themselves and grow. It also means that people can contribute based on their strengths. We don't have to be a Jack of all trades! God wants us to contribute in areas where we have mastery. Offer interest surveys to your congregation and find the right person for the right job; people enjoy giving what they are good at!

- Rev. In Jin Moon!
- You!
- Greeters
- Ushers
- Tithes collectors
- Resource table attendants
- Tech team
- Worship team and/ or worship leader
- Youth ministry team
- After-party team
- Emcee
- Local pastor
- Set up and take-down team
- Food preparers
- Outreach team

GUEST SERVICES TEAM

A place to call home

WELCOME TO YOUR CHURCH!

Guest Services is probably the most important volunteer team of Lovin' Life Ministries. Why? Because we are serving our guests so that they want to come back! If you think about it, we are providing a service! We are selling a product to our guests. A really amazing product that can allow them to inherit the true love of God! So, this part of Sunday Service cannot be overlooked. We want repeat business from our guests, and we need to serve our customer, who is a potential new member, with respect, love, and care.

Wherever your church service is held, think about how you can bring awareness of your church to the community with a positive presence. Think about signage, a friendly front entrance, nice flowers, and happy people surrounding the building, so your community will recognize your local church as a welcoming place! After all, if you invite a guest to service, you want them to know that they are going to be taken care of when they arrive and that they will not be disappointed when they leave! A church that does not present itself confidently will probably leave a new guest confused. Don't forget to promote our National Pastor, In Jin Moon, at your church. When a guest comes to visit, you want them to know that they are going to be receiving a message from the National Pastor. Be confident in your church. Sell it!

Set-Up Crew

- ☑ This volunteer team arrives about one to two hours before service to set up and prepare the room.
- ☑ Set up chairs in an orderly fashion with adequate clearance around walkways. Designate accessible areas for people who may have disabilities.
- ☑ Prepare and clean rest rooms.
- ☑ Set up resource table. Stuff tithe envelopes with weekly postcards and promotional material.
- ☑ Work with Tech team to set up necessary equipment, monitors, computers, instruments, mic's, etc.
- ☑ Put up wayfinding signage, if necessary. Update any signs outside, and do any necessary housecleaning.
- ☑ Prepare children's rooms with toys and supplies.



Greeters

Purpose

Greeters are so much more than just a pretty face on Sunday morning! The first faces seen, the first people met, are the greeters. Their responsibility is to set the atmosphere of love with smiles, hand shakes, and hugs. People go to church not only to be inspired, but to be embraced by a community of love. No one likes walking into a church, and not being acknowledged by anyone. If there is one place where you should NEVER feel alone, it's at church.

Qualification

Anyone can be a greeter, as long as you can bring a smile and can set an atmosphere of love. One of the most important things to remember when being a greeter is that YOU create the atmosphere. It does not matter what happened through out the week, you have to be someone who can always bring your best!



Best Practices

- ☑ Greeters arrive an hour early for prayer and set up.
- ☑ All greeters should be in position 15 minutes before doors open.
- ☑ Greeters welcome all congregational members and guests to Sunday Service.
- ☑ Hand out all promotional material and candy.
- ☑ Located at each entrance to church
- ☑ Welcoming but not overbearing
- ☑ Greeters distribute materials and programs to guests as they enter. Give small gifts such as mints.
- ☑ Greeters are volunteers and represent the church community (it's nice when you see your friends greet you!). In other words, Greeters should not just be the leaders of that community!
- ☑ Greeters are friendly with a nice smile!
- ☑ Greeters sign-up to volunteer on a rotating basis.
- ☑ Greeters arrive at least 30-45 minutes before service.
- ☑ Greeters are a great way to get plugged in to a volunteer team right away! Right after someone has attended the membership class, invite them to become a greeter the following week. Young people often ask to be ushers or greeters just after attending our Sunday Service.

Ushers

Purpose

Ushers set the tone and create a welcoming atmosphere for everyone. One thing all ushers must remember is this: “We can’t lose our composure!” There are many things that happen during Sunday Service; we have people needing to be seated, babies crying, people needing to locate rest rooms, tithe collection, and much more. Ushers are responsible for taking care of all these issues in a courteous and professional manner.

Qualifications

Ushers come in all sorts of sizes and shapes, but one thing they must be is someone who can be courteous and confident at the same time. Ushers must be able to approach people who are talking loudly during service, who will ask people to move over one seat in order to accommodate a family, they’re quick thinkers and problem solvers, and they understand that they control the atmosphere and that their attitude sets the mood for everyone.

Best Practices

- Ushers arrive an hour early for prayer, set up and planning
- Seat guests
- Collect tithe
- Take care of any front of house issues that come up during Sunday Service.
- Ushers are located in the main assembly room, towards entrance of the room.
- Ushers do not let guests sit in “overflow” areas until main area is filled.
- Ushers encourage guests to sit at the front of the space, paying attention to reserved seating.
- Work with head usher to resolve any logistical issues.
- At least one usher remains on duty throughout service for any latecomers.

- ☑ As the countdown approaches 5 minutes, Ushers encourage guests —especially young people — to have a seat and clear the back area. Social areas, as well as resource desk, should be located away from the main service area.
- ☑ Ushers note open and available seats once service has begun.
- ☑ Ushers bring guests to empty seats if they are late in arriving.
- ☑ Ushers make sure that the room is orderly, and is detail-oriented.
- ☑ Ushers are friendly!
- ☑ Ushers are polite and courteous, but able to take action!
- ☑ Once service begins, ushers can bring guests to the rest rooms, or to assist a family with disruptive young children who need to be taken to the child-care room.
- ☑ Ushers are volunteers who sign-up on a rotation basis.

Resource Table

- ☑ Easily accessible location, with plenty of room around it for people to “crowd” around it
- ☑ Away from main service area as to not be disruptive
- ☑ Ample lighting for reading and filling out sign-up sheets
- ☑ Clear Lovin’ Life Ministries signage that indicates the resource area
- ☑ Knowledgeable and friendly staff at table. Again, these are typically volunteers!
- ☑ Table is clean and neat
- ☑ Resources available at this table represent Lovin’ Life Ministries. Therefore, there needs to be protocols for allowing literature and material on the table. If it doesn’t meet the visual standards of graphic design or consistency with the Lovin’ Life logo or branding, then it needs to be revised before being put on the table.
- ☑ Leave enough room for people to write and fill things out



- Example of appropriate materials at the Resource Table:
 - Tithe envelopes and drop-box
 - Welcome to church brochure (in development)
 - Vision class membership class sign-up (in development)
 - Radios (for translation purposes)
 - Parking validation (where applicable)
 - Project Connect small group sign-up cards
 - Small Group leader sign-up applications
 - Contribute! cards (Volunteer sign-up)
 - Feedback cards
 - Information on other Ministries (for example, New York's youth ministry is Up&Coming, and the young adult ministry is Junction)
 - LLM brochures
 - Membership cards
 - UNews Subscriptions
 - Camp and seminar registration sheets
 - LLM Candy
 - LLM T-shirts and other merchandise
 - Information on activities at Learning Center or other community events
 - As a Peace Loving Global Citizen* and other educational books
 - Lost and Found basket
- Provide a separate COMMUNITY Board for items that can't go on the table. For example, if a member creates their own flier, or wants to put up their business cards
- Any information regarding providential events in the UC Movement should be made available on web sites and through membership e-mail distribution lists. Remember, church is "seeker" sensitive, and new guests should not be overwhelmed with providential agendas!

Marketing made easy by Lovin' Life

Lovin' Life Ministries has created a web link so that your local church community can personalize Lovin' Life Ministries' high quality flyers and program cards. Go to: <http://www.familyfed.isaprinter.com/> Choose the Lovin' Life flyer you want to use and insert your local contact information and dates etc and in minutes you have the perfect flyer! It's easy to use and designed to make your job easier. Here's the link for the print materials 7 minute training video. <http://www.screencast-o-matic.com/watch/c6f0cG1KK> We are asking that there be one administrator for each location. In other words this link should not be shared broadly with the membership as member login is limited.

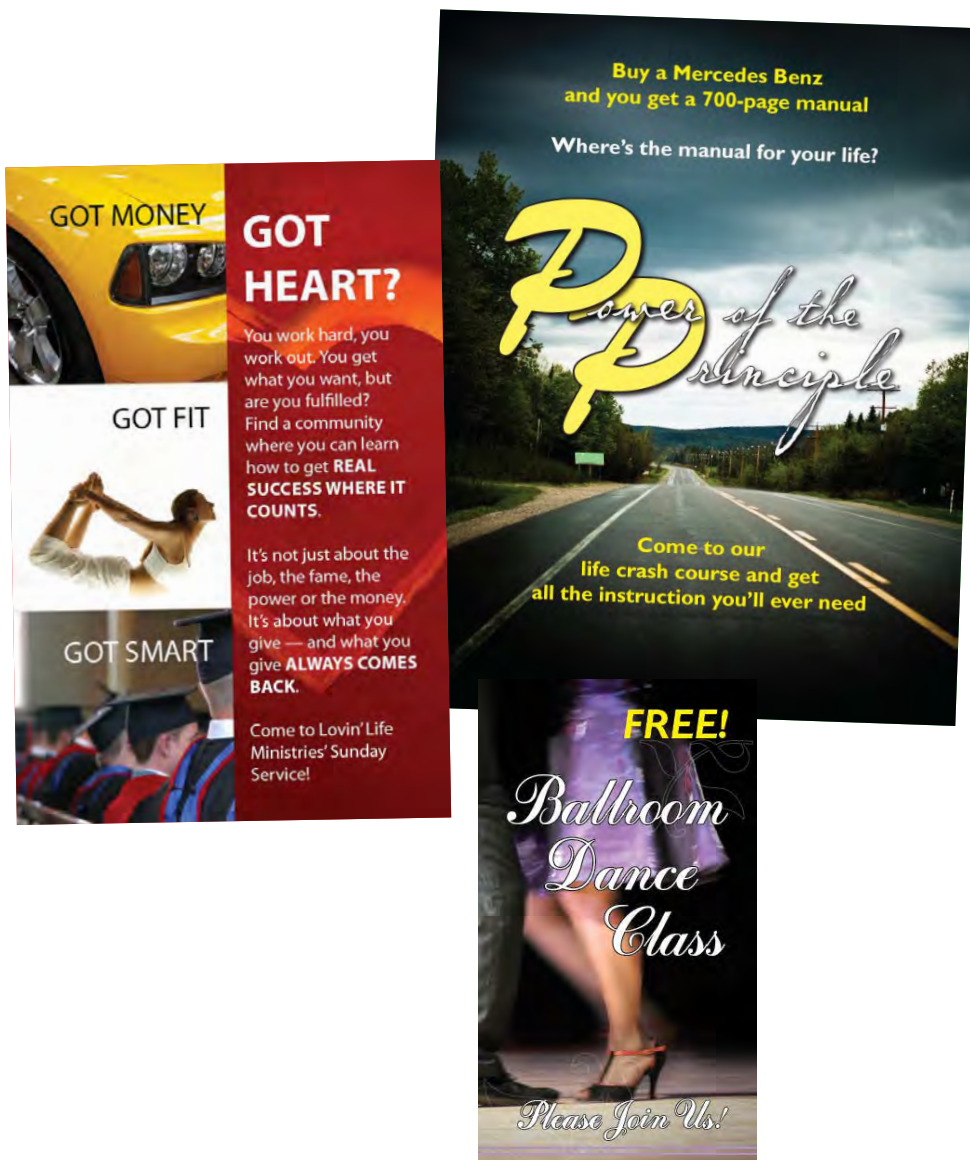

After Party Reception

- ☑ Find a nice welcoming room convenient to the main service area to accommodate the After Party.
- ☑ Invite new guests during service and invite them to the After Party immediately following service.
- ☑ Sign-in Guest Book
- ☑ Easily accessible location, with plenty of room around it for people to “crowd” around it
- ☑ Set up a comfortable room with nice seating.
- ☑ Nice background music a plus!
- ☑ Have “Creating a Life You Love” video playing on a visible screen (in development)
- ☑ Whoever talks to a new guest should write their name next to the guest’s name in the guest book to make it easier for the volunteer who is following up with them later that week. This gives a reference of contact.



- Have a front table with a greeter inviting guests to sign a guest book. Provide a nice gift representing LLM. Gift must meet standards of LLM.
- Follow up with an e-mail to guests, thanking them for coming.
- After Party is not for new guests alone! It should be a place for all members, new and old, to stop by and mingle and meet new guests!
- Provide good coffee and refreshments.
- Light-fare food and snacks are acceptable, but be careful not to provide too much food because it can create the wrong atmosphere (members can be attracted to the food...and not the new guests!)
- Local pastor should be available at the reception to meet new guests directly, as well as youth pastors and any other staff.
- The After Party is a VERY effective tool to provide the opportunity of “repeat business” from new guests! This is where new guests will get a chance to “try the community on for size” to see if they belong! If they are welcomed with a smile, and engage in a nice friendly conversation, they have a much higher chance of returning!
- Provide ONE brochure of LLM to the new guests. Perhaps recommend ONE activity in the community or small group that you think fits their personality. You do not want to overwhelm them!
- Take the opportunity to listen to the guests and answer their questions.
- Accept new guests where they are at! The reception is a soft witnessing tool. We don't want to look desperate for members!
- Members who bring a guest should be encouraged to go with them to the After Party.
- Walk-ins should be identified by greeters and local staff. A staff member should then introduce themselves and make sure they go to the After Party.

Production

4 Ways of Displaying the LLM Service Video presentations

- #1: DVD using DVD Player. A SONY DVD player is strongly recommended. This should be acquired as soon as possible.
- #2: DVD using computer. Not recommended at all,
- #3: Streaming video using a dedicated computer. Satellites reaching a certain size will be given a dedicated computer by HSA HQ.
- #4: Stream Box provided by HSA HQ for the largest satellite churches.

What you need

- A 3000 lumen (or greater) projector
- Screen. Do NOT show the broadcast or DVD on a wall. Projection on a wall will result in greatly diminished picture quality.
- Monitor for MC and Song Leaders (optimal)
- Audio system (more detail in Audio Section)
- Cables and adaptors (more detail later)

and

- #1 : DVD player
- #2: Optimized Computer, Software DVD Player and Monitor Splitter
- #3: Optimized (Dedicated) Computer, Software DVD Player and Monitor Splitter
- #4: Stream Box

For Bigger service you may need:

- ☑ 2nd computer to project lyrics of the songs that local band plays

Connecting together any one of these 4 ways of video presentation, you need to display video on one or two devices. One is the projector for everyone, one is the optional monitor (or TV) for the MC and Song leaders who are facing the audience and can't see the screen. Ideally, you need to split the video signal into 2 devices.

- ☑ #1: DVD Player

It is simple. DVD players can output the same video signal two or three ways. You can use "Component (Red, Green, Blue - 3 connectors)" or "S-Video (1 connectors with 4 pins)" to connect the DVD player to your Projector, and use "Composite (1 connector, usually yellow color)" to connect DVD player to MC Monitor.





- 1, <Best Quality> Component (Red, Green, Blue - 3 connectors)
- 2, <Good Quality > S-Video (1 connector with 4 pins)
- 3, <OK Quality > Composite (1 connector, usually yellow color)

- ☑ #2 & 3: Computers

You need to split computer monitor signal into 2.

What you need:



- 1 VGA (Computer Monitor) cable from computer to Splitter
- 1 Splitter
- 2 VGA (Computer Monitor) cables from Splitter to Projector and Monitor

<p>CablesToGo UXGA Splitter</p> 		<p>http://www.bhphotovideo.com/bnh/controller/home?O=WishList.jsp&A=details&Q=&sku=588648&is=REG</p> <p>1x VGA Input, 2x VGA Output Supports resolutions Up to 1920 x 1440 Split VGA signal to multiple sources, Up to 210' B&H # CA29550 Price: \$ 38.95</p>
<p>Cable between computer to splitter</p>	<p>Male to Female VGA Extension cable</p>	<p>10' Belkin \$8.25, Cables ToGo \$19.95 36' InFocus \$49 50' Mirror Image \$98.95</p>
<p>Cable from Splitter to Projector & Monitor</p>	<p>Male to Male VGA cable (Need 2 of these)</p>	<p>10' Belkin \$8.25 25' Comprehensive \$29.95 50' Comprehensive \$73.95</p>

☑ #4: Stream Box

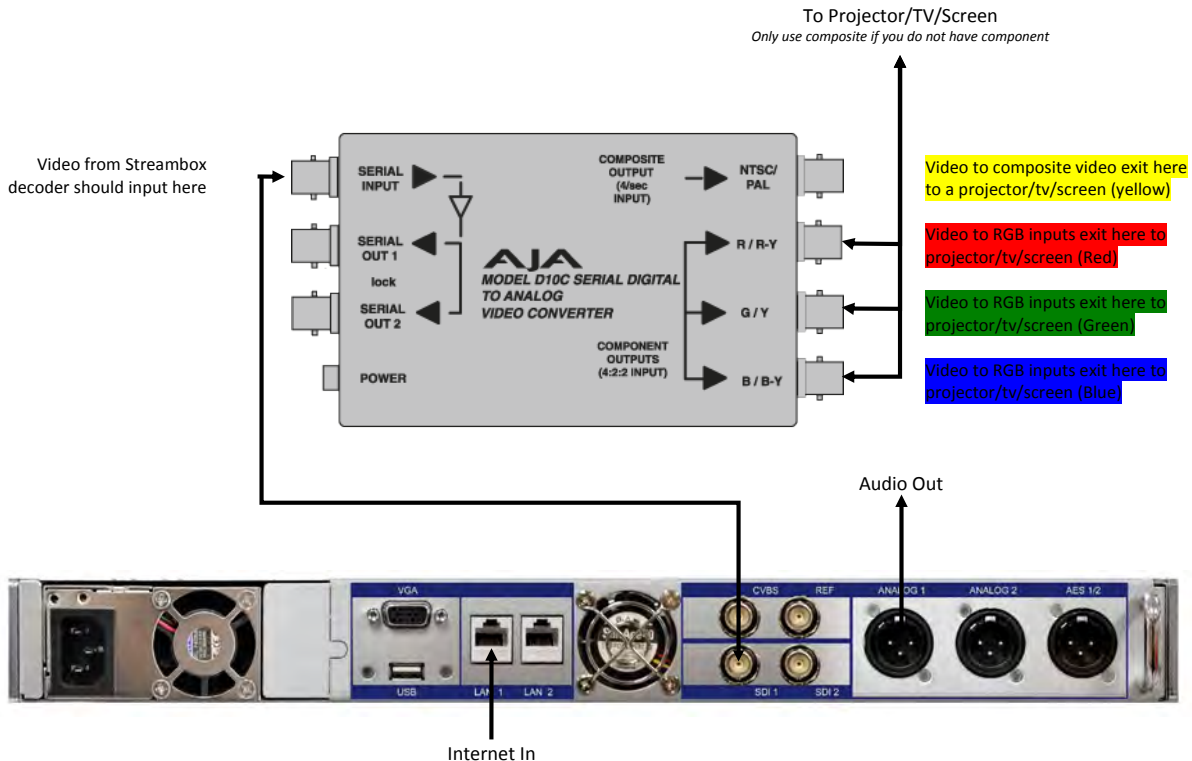
Stream Box comes with Digital to Analog converter made by "AJA"
This converter out puts 2 video signals simultaneously. We can connect Projector and Monitor to the Converter Box.

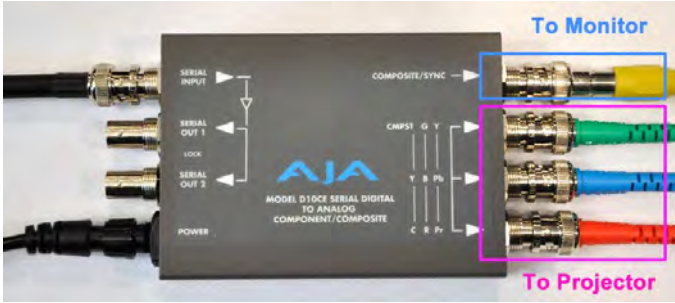
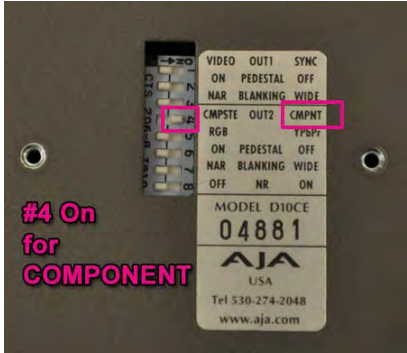
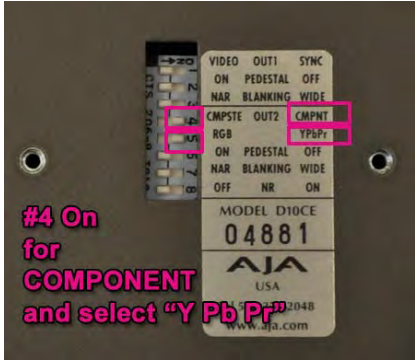
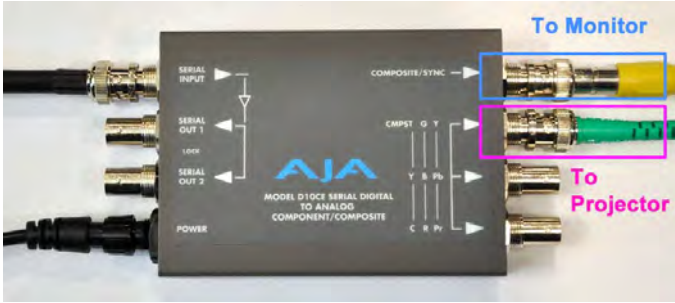
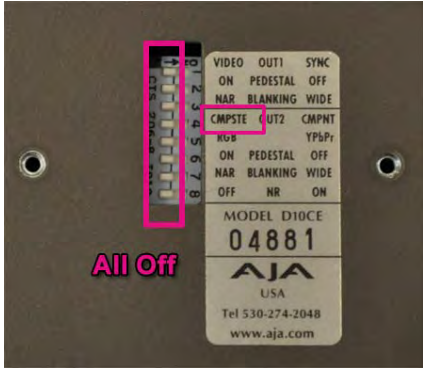

<p>Top of AJA adapter</p> 	<p>Back of adapter</p>  <p>To use this connection, you need to change dip switch #4 to on position.</p>
<p>some projectors want to see “Y Pb Pr” signal instead of “RGB”, for that try switch #5</p>	 <p>#4 On for COMPONENT and select “Y Pb Pr”</p>
<p>if your projector doesn't have RGB input, use this connector (one cable)</p> 	 <p>All Off</p> <p>You don't need to change the dip switch in the back.</p>
 <p>RCA Cable BNC to RCA adapter</p> <p>You may need a “BNC to RCA” adapter to connect commonly used video cables (RCA cable) to AJA Box</p>	<p>They are \$2.39 each at B&H (New York City store) Hosa Technology NBR253 Male BNC to Female RCA Adapter (B&H# HOABMRF) “http://www.bhphotovideo.com/c/product/408187-REG/Hosa_Technology_NBR_253_NBR253_BNC_to_RCA.html”</p>

Aspect Ratio

The video industry is moving to wide screen (16:9) format. We are in the middle of a transition period at LLM. Almost all the videos we produced last year were in 4:3 format. But from the beginning of this year our production switched to wide screen 16:9 format completely. Because of this we have two different formats of LLM service video (for a while). All the DVDs from last year are in 4:3 format and Live Stream is in 16:9 format. We are sorry for the inconvenience but once we finish showing all of last year's DVDs, we will only have the 16:9 format wide screen video.

Please pay attention to the video format we are using each week. If you receive the LLM DVDs from head quarters, most likely they are in 4:3 format. The LIVE streaming service is in 16:9 wide format, except on the occasions we stream last year's DVD content, that will be in 4:3 format. We will inform you if we stream 4:3 format video.



4:3 SCREEN

VI-A



4:3 video on 4:3 screen
correctly displayed

16:9 SCREEN

V2-A



16:9 video on 16:9 screen
correctly displayed

VI-B



16:9 video squashed on 4:3 screen
incorrectly displayed

V2-B



4:3 video stretched on 16:9 screen
incorrectly displayed

VI-C

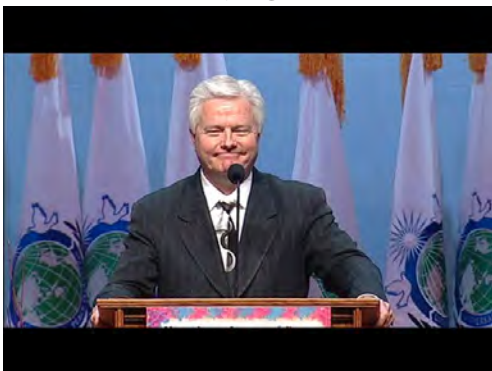

16:9 video properly displayed on 4:3 screen
(If you have 4:3 screen, show 16:9 video this way.)
correctly displayed



V2-C



4:3 video properly displayed on 16:9 screen
(If you have 16:9 screen, show 4:3 video this way.)
correctly displayed

Set up DVD player's proper aspect ratio

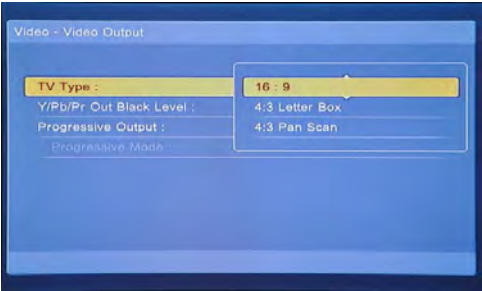
If you have a 4:3 system and can't show 16:9 video properly, please take time to set up your DVD player if your video is not properly displayed on your screen. Your remote control should have a button labeled "Set Up", "System Menu" or "Function" depending on the company makes it. (Not the "Menu" button that takes you to DVD menu.) Find the "TV Type" or "TV Shape" section. Change your setting to 4x3 or 16:9 to display the video properly (V1-C).

	
Example of Sony DVD player (Select 4:3 Letter Box to show 16:9 video on 4:3 monitor)	Example of Toshiba DVD player

If you have 16:9 monitor and can't display 4:3 video properly, please change the "Aspect" of your monitor (to see in the way "V2-C" shows).



Recommended Equipment

Projectors



We highly recommend a 3000 lumen or higher projector. This is very important for Sunday Service quality. The projector needs to have one or two video inputs, and ideally the following:

- 1, <Best Quality> Component (Red, Green, Blue - 3 connectors)
- 2, <Good Quality > S-Video (1 connector with 4 pins)
- 3, <OK Quality > Composite (1 connector, usually yellow color)

Screens

Examples of some floor-standing model 16:9 screens at B&H store. Ideally a wall-mounted screen is best. For a smaller satellite church, a floor-standing model can be used.

	<p>Epson Duet Ultra Portable Projector Screen with Both Video (4:3 Aspect Ratio) and HDTV (16:9 Aspect Ratio) Formats 4:3 format: 42.5 x 61.75" (1 x 1.6m) 16:9 format: 42.5 x 79.5" (1 x 2m) B&H # EPELPSC80, Mfr # ELPSC80, Price: \$ 119.95 Free Shipping (USA) Usually ships in 7-14 business days * Important Notice! This is not a regularly stocked item. Estimated arrival at B&H is 7-14 business days. You will be charged upon placing your order.</p>
	<p>Vutec Tripod Projection Screen (S-Series, 45 x 80"), 92" Diagonal, 16:9 Aspect Ratio, BriteWhite surface B&H# VUTS4580S, Mfr#01-EVTR4580S, Price: \$ 124.95 * Important Notice! Item will be drop shipped directly from the manufacturer/distributor. Item is non-cancelable and non-returnable. Usually ships in 7-10 days. Usually ships in 7-10 days</p>

	<p>Da-Lite 86017 Picture King Portable Tripod Front Projection Screen (45 x 80\"), 92\" Diagonal 16:9 Aspect Ratio, Matte White Finish B&H# DAPK4580MW, Mfr# 86017, Price: \$ 239.95 Item will be drop shipped directly from the manufacturer/distributor. Item is non-cancelable and non-returnable. Usually ships in 7-10 days.</p>
	<p>Da-Lite Deluxe Complete Fast-Fold Portable Front Projection Screen - 69 x 120\" - 133\" Diagonal - HDTV Format (16:9 Aspect) - DA-Mat B&H # DAFFD69120DM, Mfr # 88608, Price : \$ 696.95 * Important Notice! Item will be drop shipped directly from the manufacturer/distributor. Item is non-cancelable and non-returnable. Usually ships in 7-10 days.</p>



Monitors

Example of TV Monitor for MC and Song Leaders on Stage (important connection to look for is highlighted as red letter)

	<p>Viewsonic VT2230 22\" Widescreen LCD HDTV Full HD 1920 x 1080 LCD Panel Input connectors HDMI, Component, S-Video, Composite, PC VGA (15-Pin D-Sub) B&H# VIVT2230, Mfr# VT2230, Price: \$ 220.09</p>
---	--

Cables and Adapters

<p>#1 DVD Player</p>	<p>RGB Cable (RCA connectors) or S-Video cable Composite Video Cable (RCA connectors) Audio Cables: - Short to medium distance: (RCA cable + RCA to 1/4" adapters) - Very long distance: RCA + DI + XLR (mic) Cable</p>	<p>3 RCA to 3 RCA Cable - 25 ft \$20</p>  <p>S-Video Cable - 25 ft \$18, - 50 ft \$28</p>  <p>RCA to RCA Stereo audio cable -25 ft \$24, - 50 ft \$33</p>  <p>Male 1/4" Phone to Female RCA Adapter- 2 Pieces \$2 (for two)</p> 
<p>#2 & 3 Computer</p>	<p>VGA extension Cable, VGA Splitter, 2 VGA Cables Audio Cables: Stereo Mini to RCA Cable + RCA to 1/4" adapters</p>	<p>VGA extension Cable 10 ft \$8.25 VGA Cables 25 ft \$29.95 (each) Splitter \$39 Stereo Mini to 2 Female RCA Adapter \$2</p> 

<p>#4 Stream Box</p>	<p>RGB cable (BNC connectors) included (for Projector) Composite Cable (BNC to RCA Cable) (For MC Monitor) You may need an extra BNC cable + BNC to BNC adapter (Between Box to AJA Adapter) Audio Cables: XLR (mic) Cable</p>	<p>BNC Male to RCA Male Cable - 50 ft Price: \$24</p>  <p>BNC Male to BNC Male Cable - 25 ft Price: \$16 50 ft Price: \$25 Female BNC to Female BNC Adapter</p>  <p>Price: \$ 2.39</p>
<p>Around “Audio Mixing Board”</p>	<p>2 RCA to 1/4” adapters You may need XLR to 1/4” adapter.</p>	

Audio connections

Most small mixing boards have a “Tape Input”. You can connect your DVD player or computer’s audio cables there. But you do not have as much control this way.



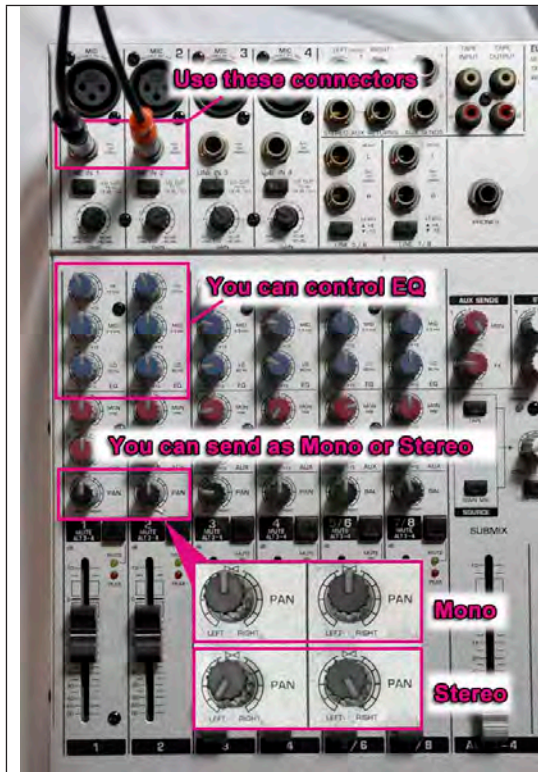

A better way to connect audio from a DVD and/or a computer is to use “a male ¼ inch phone to female RCA adapter” (Two for \$2).



Then connect them to the inputs above the faders and EQ. This way you have control of volume and tone using the EQ. You can cut down uncomfortable high pitch sound by changing the EQ settings. For mono sound, use the PAN controls to produce stereo sound.

The audio person should stay in the middle or the back of the room where he/she can hear what everyone else hears.

Questions

- Do you have a projection screen?
- Do you have curtains to make the room dark enough for projection? It is strongly recommended that the room during the three offertory songs and Rev. In Jin Moon’s sermon be completely dark.
- You can check your connection speed to internet by visiting this site
<http://www.speedtest.net>
 It tells you your “Download Speed” and “Upload Speed”.
 Please let us know your speed. Please check it each Sunday morning.

Suggested PA system with backup singers

Mixer Mackie 802-VLZ3	\$ 200
Speakers Mackie SRM450v2 \$600 X 2	\$1200
Mics Shure Beta 58A \$150 X 3	\$450
XLRcables \$50 X 6	\$300
Mic stands \$50 X 3	\$150
Speaker stand \$50 X 2	\$100
TOTAL	\$2400

Suggested PA system with full band

Mixer Mackie 1604-VLZ3	\$900
Speakers Mackie SRM450v2 \$600 X 3	1800
Sub woofer Mackie HD1801	\$1000
Mics Shure Beta 58A \$150 X 8	1200
DI box Radial ProDI \$100 X 2	200
Mic stands \$50 X 4	200
Compressors dbx 1046	\$530
Eq/compressor dbx DriveRack PX	\$400
Speaker stand \$50 X 2	\$100
XLRcables \$50 X 12	\$600
TOTAL	\$7,130

Our National Pastor is aware that financial resources are currently limited. This list should serve as a goal to be achieved as membership grows.

TECH TEAM

Sunday Service Order and Transitions

Lovin' Life Ministries would like to outline for you the different scenarios that a Lovin' Life Satellite church may implement. Your satellite Sunday Service production should match the quality of our National Pastor's sincere offering. Lovin' Life Ministries would like to share some "best practices" with you. The most important step to achieving these, however, is through practice, practice, practice!

On the occasional Sundays that In Jin Nim is not available for live broadcast and the satellite churches are requested to show a DVD, the most optimal viewing is done with a SONY DVD player. The quality of laptops varies and determines the quality of the showing, which can be guaranteed by the SONY DVD player.

The scenario with only back-up singers is intended for a congregation that does not have a complete band but does have a small choir. The singers should be seen by the congregation, and yet should be able to see the lyrics of the songs by having their own monitor. We suggest that they be placed on the side and on a slight elevation if available. The singers should be heard by the congregation together with the sound of the Lovin' Life band through broadcast.

When a community has a full band available to them, they should practice to be at the same level of the Lovin' Life band. This is the standard of excellence we should strive for. We strongly suggest that the band play a total of 3 songs. The first song will be before the 10 second broadcast countdown in order to gather the congregation and establish the spiritual atmosphere. After which the congregation will tune into the live broadcast and follow the countdown. The last two songs offered by the local band are the finale song "Everlasting Love" and the one right before it. The congregation can tune out after the message board and listen to their own local live band while projecting the lyrics of both songs to have the members follow along.

Both scenarios have the option during the prayer to either participate with the broadcast, or to invite their own local Ambassador for Peace or ACLC member to give a prayer of benediction. Inviting local AFP/ ACLC members is a way to reconnect them to the community and have them contribute and be involved. This is what our National Pastor recommends.

The following are some of the best practices that we have gained through experiences from the field.

The Emcee has a most critical role and must be an enthusiastic young adult from the community. He/she has the important role of guiding the congregation in participating along with the live broadcast, indicating when to stand, sing along, etc; he/she must be knowledgeable in coordinating the times between the local service and the broadcast, cued in by the IT director.

A lot of effort is put into the Lovin' Life message board, and it is an opportunity for the community to be informed of international and national events, meetings, and local activities in the Tri-state area. Brief local announcements from the community should be given after the service is over and preferably when any guests have left to attend the after party. In doing so we are keeping Sunday Service guest friendly.

The tithing message is important for all to hear, and a basket should be passed around the congregation just as during Lovin' Life. Single file lines to the stage for making an offering take much more time and distract from the main Sunday Service experience.

3rd grade students and above should all participate in Sunday Service. After the service has concluded, the congregation should be invited to attend the Circles, such as the women's circle, men's circle, high school circle, and junior circle. Communities should also have a toddler room available for the younger children to be kept occupied.

The following is an outline of the different types of Sunday Services our National Pastor is recommending. The first is with live backup singers to help the congregation sing at the start and end of Sunday Service. The second is when a satellite community has a high quality live band that practices regularly, learns the LLM repertoire, and is prepared to play the music our National Pastor has picked for each service.



Scenario with Song Leaders

- After doors open, the local MC gives welcoming remarks to gather the congregation.
- The service starts with the 10 second countdown. Right before it finishes the local MC guides the congregation into rising and singing the opening two songs. Then they all tune into Dave Hunters welcoming remarks.
- The local choir prepares the congregational songs that the Lovin' Life band will be performing. They will sing along with the band for the first 2 songs. After which they exit the stage when the offering songs come on.
- The congregation watches and when our National Pastor comes on stage, the local MC guides the congregation to stand and greet her. .
- For the prayer, centers have two choices. They can participate through live broadcast, or they may invite a local Ambassador for Peace or ACLC member to give the benediction prayer. If the second option is implemented, the video sound fades out while the local preacher starts the benediction prayer. After which the local MC will initiate the Meet and Greet. During the Meet and Greet the volume from the live broadcast is on low, but gradually increases, so the audience can hear the chatter and background music from the Manhattan Center.
- The volume should be high by the time Jaga's tithe message begins, and baskets should be passed in the satellite church.
- The lights turn off for the message board and the local singers go back on stage for the last 2 songs (last one being "Everlasting Love").
- After Dave Hunter's closing remarks, the local MC can follow up with his/her own closing remarks. Local announcements should be given after the conclusion of Sunday Service and after any guests that were present have left to attend the After Party.

SCENARIO WITH SONG LEADERS

Time	Event	Scenario Song Leaders	Talent/ Stage	Projector	Sound	Lights
9:00 AM	Broadcast Test					
9:30 AM	Doors Open	Doors Open		logo	IJN CD background	House lights 100%
9:50 AM			Singers Gear Pre-set			
10:04 AM			Choir and MC enters			
10:04AM		Local MC welcoming remarks fills time up to countdown	local MC			
				lyrics via PowerPoint	Choir Mic	
				logo		
10:04:50		Tune in for Countdown		video countdown	Video Volume High	lights 50% for countdown
	Countdown	Countdown		Live broadcast/ DVD		
		MC guides congregation to stand	Local MC		MC mic	
10:05 AM	NY MC welcome	Tune in		Live broadcast/ DVD	Video volume high	lights 50%
10:06 AM	Congregational Song 1	Back up singers sing	Singers/ video	Live broadcast/ DVD	Choir Mics- video volume high	lights 50%
10:10 AM	Congregational song 2	Back up singers sing	Singers/ video	Live broadcast/ DVD	Choir Mics- video volume high	lights 50%
			singers exit			
10:11AM	MC Remarks	Tune in to Dave	Live broadcast/ DVD	Live broadcast/ DVD		lights 50%
10:12AM	Offering Song 1	no singers	Live broadcast/ DVD	Live broadcast/ DVD		lights off
10:16 AM	Offering Song 2	no singers	Live broadcast/ DVD	Live broadcast/ DVD		lights off
10:20AM	Offering Song 3	no singers	Live broadcast/ DVD	Live broadcast/ DVD		lights off
10:23AM	Occasional Scripture Reading					lights off
			MC enters			
		local MC guides congregation to rise and greet IJN	local MC		MC mic	lights remain off
10:27 AM	Sermon - Rev. In Jin Moon		Live broadcast/ DVD	Live broadcast/ DVD	video volume high	

	Sermon ends	local MC guides congregation to rise in appreciation	local MC		MC mic	lights off
			Minister enters			
11:10 AM	Minister's response and prayer (MC mic)	either let broadcast run OR volume off and have local AFP pray	(maybe) local AFP	Live broadcast/ DVD	video volume high OR video volume off; Pianist plays Background Music; Minister on Wireless	lights off OR 50%
			MC enters			
11:13 AM	Meet and greet - MC	volume off- MC initiates local meet and greet- volume low to hear NY chatter, volume slowly rises to full	local MC	Live broadcast/ DVD	video volume off- MC mic- video volume low	lights 50%
			Congregation			
			Ushers prepare for Offering			
11:15 AM	Tithe	tune in to Jaga's talk and pass baskets	Live broadcast/ DVD	Live broadcast/ DVD	video volume high	lights 50%
11:18AM	Announcement video	lights out- tune in	Live broadcast/ DVD	Live broadcast/ DVD		lights off
			Choir/Backups return			
11:21AM	Offering song 1	Back up singers	Singers/ video	Live broadcast/ DVD	Video volume high Band, Choir & backup mics	lights 50%
11:25 AM	FINALE SONG - "Everlasting Love"	Back up singers	Singers	Live broadcast/ DVD	Video volume high Choir mics	lights 50%
			MC enters			
11:30AM	NY MC-Closing remarks	MC- closing remarks with no video	local MC	logo	MC mic	lights 100%
10:31 AM	Broadcast ends		local MC remarks	logo	MC mic	lights 100%
		Local announcements after guests go to After Party	local MC			
	Optional food					

Scenario with a Full Band and Singers

- After the doors open, the band is ready to play its first song minutes before the 10 second countdown. The local MC welcomes the congregation, and invites the band to play a song of their choice with lyrics projected on screen, or handed out to the congregation. The first band song before LLM starts is optional.
- Then the congregation tunes into the live broadcast for the 10 second countdown. The singers of the local band stay on stage in order to follow the Lovin' Life band's songs. They leave when Dave Hunter introduces the LL Band's offering songs. The congregation then follows the broadcast. Lights are off for the three songs and the sermon.
- The local MC will guide the congregation in greeting In Jin Nim.
- For the benediction prayer, the community can choose between the two scenarios (follow broadcast or have a local AFP come) like in the scenario with just song leaders outlined above.
- The local MC leads the Meet and Greet, with low volume at first, then increasing, then tune in to Jaga's tithe talk while baskets are passed.
- Lights out for the Lovin' Life message board.
- After the message board the local band can play a song of their choosing with lyrics projected by PowerPoint. The last song should be "Everlasting Love", again with lyrics projected.
- The local MC gives closing remarks, and then brief local announcements can be made after guests leave for the After Party.

This information will help you and your congregation achieve the best results. The experience will be exciting and engaging for all.

SCENARIO WITH FULL BAND AND SINGERS

Time	Event LLM Broadcast	Scenario Full Band Local	Talent/Stage	Projector	Sound	Lights
9:00 AM	Broadcast Test					
9:30AM	Doors Open	Doors Open		logo	IJN CD background music	House lights 100%
9:59 AM			MC, Band & Choir enters / Choir on risers			
9:59 AM			Band Vamping			
10 AM		MC welcoming remarks	local MC			
		Band plays song of own choosing	Lead Vocals/Band/Choir/Backups	lyrics via PowerPoint	Band and Choir Mics	
			Band exits/ singers stay	logo		
10:04 AM		Local MC opening remarks fills time up to countdown	Local MC			
		Tune in for Countdown		video countdown	Video Volume High	lights 50% for broadcast countdown
10:05 AM	Countdown	Countdown	MC enters	Live broadcast/ DVD		
10:05 AM		MC guides congregation to stand	Local MC		MC mic	
10:05 AM	MC welcome	Tune in		Live broadcast/ DVD	Video volume high	lights 50%
10:06 AM	Congregational Song 1	Back up singers sing	Singers	Live broadcast/ DVD	Choir Mics- video volume high	lights 50%
10:10 AM	Congregational song 2	Back up singers sing	Singers	Live broadcast/ DVD	Choir Mics- video volume high	lights 50%
			singers exit			
10:11AM	MC Remarks	Tune in to Dave	Live broadcast/ DVD	Live broadcast/ DVD		lights 50%
10:12AM	Offering Song 1	no singers	Live broadcast/ DVD	Live broadcast/ DVD		lights off
10:16 AM	Offering Song 2	no singers	Live broadcast/ DVD	Live broadcast/ DVD		lights off
10:20AM	Offering Song 3	no singers	Live broadcast/ DVD	Live broadcast/ DVD		lights off
10:23AM	Occasional Scripture Reading					
			MC enters			
		local MC guides congregation to rise and greet IJN	local MC		MC mic	lights off

10:27 AM	Sermon - Rev. In Jin Moon		Live broadcast/ DVD	Live broadcast/ DVD	video volume high	lights off
			MC enters			
		local MC guides congregation to rise in appreciation	local MC		MC mic	lights 50%
			Minister enters			
11:10 AM	Response and prayer (MC mic)	either let broadcast run OR volume off and have local AFP pray	(maybe) local AFP	Live broadcast/ DVD	video volume high OR video volume off; Pianist plays Background Music; Minister on Wireless	lights off OR 50%
			MC enters			
11:13 AM	Meet and greet - MC	volume off- MC initiates local meet and greet- volume low to hear NY chatter, increasing slowly	local MC	Live broadcast/ DVD	video volume off- MC mic- video volume low	Lights 50%
			Congregation			
			Ushers prepare for Offering			
11:15 AM	Offering	tune in to Jaga's talk and pass baskets	Live broadcast/ DVD	Live broadcast/ DVD	video volume high	Lights 50%
11:18AM	Announcement video	lights out- tune in	Live broadcast/ DVD	Live broadcast/ DVD		lights off
			Band/Backups return			
11:21AM	Offering song 1	offering song of band's choice with powerpoint lyrics	Lead Vocals/Band/Choir/Backups	lyrics via PowerPoint	Video volume off; Band, Choir & backup mics	lights 100% for powerpoint
11:25 AM	FINALE SONG - "Everlasting Love"	final song with powerpoing lyrics	Lead Vocals/Band/Choir/Backups	lyrics via PowerPoint	Video volume off; Band, Choir & backup mics	lights 100% for powerpoint
			MC enters			
11:30AM	MC-Closing remarks	MC- closing remarks with no video	local MC	logo	MC mic	lights 100%
		Local announcements after guests go to After Party	local MC			
	Optional food					

CREATIVE TEAM

The experience makers

EmCee

Purpose of the MC role

Contrary to popular belief, the main purpose of having an MC in Sunday Service is NOT to announce the next item of the liturgy or the Sunday Service schedule. The phrase every Sunday Service MC should avoid is, “Next we will sing...” or “Now so and so will give the tithe message.” The real purpose of an MC is to manage and guide the spirit of the service, so that the congregation is uplifted, inspired, and ready to receive the Pastor’s message. Sunday Service should always be uplifting and inspiring, and therefore the MC should try to create that same type of atmosphere every week – one that will allow God’s Spirit to be present.

Qualifications

A great MC is one that can lead by example. Since the primary purpose of the MC is to inspire and uplift the audience, the major qualification of a good MC is one that is easily inspired and uplifted him/herself. Most people walk into Sunday Service with heavy burdens after a long week of work or school. But the good news is that the congregation wants to be inspired, so if the MC is excited to be at church and greets the audience as such, the congregation will follow suit. In addition, an MC should have strong public speaking skills, and be able to develop very short inspirational messages “on the fly.”

MC Best Practices for LLM Liturgy

There are five key points in the LLM Sunday Service during which the local MC engages the audience. The following will help local MCs develop talking points for each of these five points during the service.

1. MC Welcome
2. Guide congregation to rise and greet our National Pastor
3. Lead applause after sermon
4. Lead Meet & Greet
5. Closing remarks

1. MC Welcome

During the MC Welcome, you as the MC are the first person to engage the church congregation. Internally, you are setting the tone (spirit) for the entire Sunday Service, so you should have a lot of energy and sound excited to be at church. You should also make people feel welcome and ready to worship together. Externally, your job is to welcome people to Lovin' Life Ministries and to prepare them to sing the congregational songs. People should rise to their feet and sing along, so you should incorporate that into your welcome. You may also want to find a way to introduce the first congregational song, but it is not completely necessary (see recommendation #3 below for an idea of how to incorporate an introduction to the first song). In general, you want to get people excited about church and worship. Here are some ideas from what Dave Hunter uses at LLM in Manhattan:

“Good morning brothers and sisters. Welcome to Lovin' Life Ministries! We hope you're ready to feel the spirit so let's get on our feet and sing some Holy Songs because it's time to praise the Lord!”

“Good morning brothers and sisters. Welcome to Lovin' Life Ministries here at New York's historic Manhattan Center! Brothers and sisters it's time to get the spirit moving in God's house so let's rise and sing some Holy Songs because it's been too long since last Sunday!”

“Good morning brothers and sisters. Welcome to Lovin' Life Ministries here at the Ohio Family Church (or Bay Area Family Church, etc.). You know one of the best ways to feel God's love is to tell our Heavenly Parent how we feel today so why don't we go down to the riverside to lay down our burdens.

2. Guide congregation to rise and greet our National Pastor

Everything that has happened up to this point in the service is preparation to set the correct spiritual tone and atmosphere to receive the National Pastor's message. The MC should respectfully introduce our National Pastor, lead the congregation in applause, and leave the stage as that dies down.

3. Lead applause after sermon

The MC joins in applause with the congregation. As that ends, the MC respectfully thanks the National Pastor for the message. This can be quite brief. The MC then briefly introduces the local prayer-giver.

4. Meet & Greet

This item of the liturgy is the only point during the service where the MC is simply directing the congregation what to do – to greet each other. The purpose of the meet & greet is obviously to give the congregation time to quickly share in fellowship with each other and ideally, briefly talk about the message of the sermon. This can be done simply by saying, "Brothers and sisters, let's take a few minutes to share in fellowship with each other."

One possible internal variation that can be added to this element of the liturgy is to suggest that the congregation "practice" some element from the sermon. For example, if In Jin Nim talks about the power of gratitude in her sermon (a recurring theme in many of her messages), the MC could say, "brothers and sisters, let's take a few minutes and express our gratitude for our brothers and sisters sitting next to us." It's a simple twist to the meet & greet, but it gives positive reinforcement to the message and gives the congregation the opportunity to apply The Principle to their daily life.

5. MC Closing Remarks

Just as the MC is the first person to greet the congregation, he or she is also the last person to officially send them off for the rest of the week. Therefore, the closing remarks are equally, if not more important than the Welcome. Some may think that the closing remarks are just a formality and for some, an excuse to yell into the microphone. Internally, however, the MC should be trying to help the congregation leave in the highest spirits possible. The congregation has just



listened to some awesome music and heard a great message from our Pastor. The MC has to try to make that feeling last for an entire week. At LLM in Manhattan, the congregation has become accustomed to the MC asking them, “Are you lovin’ life?” with an expected response. It is also good practice to wish everyone a great week and remind them that God is with them (God Bless You!).

It is even better practice, however, to reinforce the message contained within the sermon. One week for example, In Jin Nim talked about the power of the mind to shape the individual. She said that we have to be careful not to think of ourselves as worthless, invisible, or as a failure. Instead, she suggested that we are priceless children of God; that God always sees us, and when we look at ourselves as works in progress instead of failures, we become fearless. In this case, the MC closed out the service in this way:

“Brothers and sisters, are you lovin’ life?” (YES!) “I can’t here you, are you lovin’ life?” (YES!) “Go out this week and remember that you are priceless! God sees you! And you are fearless children of our True Parents! Have a great week, and God Bless You!”

Feel free to contact David Hunter with any questions you may have.

Youth at Sunday Service!

Empowering the next generation

Getting the next generation involved is a big part of Lovin' Life. This is why its essential to involve youth and young adults in all aspects of the ministry from the choir and music team to leadership positions such as the Emcee. It's important for young people in the audience to see themselves reflected in the Lovin' Life Service. Generation Peace is front and center at Lovin' Life.

Lovin' Life is for families! We are creating a culture where families can worship together on Sundays. Children, 4th grade and up can attend Sunday Service while younger children can be in an appropriate setting in an adjacent room. In particular, our National Pastor has a God-given gift of speaking to the hearts of our children. She is speaking to them and by attending Sunday Service, our children build a direct connection and relationship with her. In Jin Nim often says never underestimate young children, even when they are not listening, they are listening. She has asked to have these young children attend her Sunday Service and then attend Sunday School after the service to reinforce the message in an age-appropriate manner.



EMPOWER!

We want every new friend attending Sunday Service to learn more about Lovin' Life Ministries; who we are and what we believe. The first step is to invite our guests to an After Party where they can meet members. Make sure the MC, Youth Pastor and other members who feel comfortable talking with guests are available for conversation. This is an important opportunity to get to know the guest personally.

After attending and participating in the ministry for a period of time guests are invited to attend a Vision Class, which is Lovin' Life's membership class. These occur once a month on a BOOST Sunday, after lunch. Classes are 4 hours in length and introduce guests to the Ministry and include an invitation to join membership. More information about BOOST and membership classes will be distributed in the upcoming weeks. A Tool kit will provide you with all you need to hold an engaging membership class and continuing education for new members.

Empower is the element of the ministry that supports spiritual growth through education and enables us to develop our faith and relationship with God and True Parents so that we can inherit the true love of God.



CONNECT!

To connect is the third leg of the “LLM stool”. We may feel Inspired by the Sunday sermon and Empowered by the content of our educational programs, but we are not going to stick around and become a member of the community if we don’t feel personally connected to one another. Project Connect makes use of the small group model in order to provide a place where members and guests can experience that connection.

Lovin’ Life Circles

After Sunday Service the congregation is invited to join one of our Circles. These include the Men’s Circle, Women’s Circle, Young Adult Circle and High School Circle. Elementary and Middle school children can attend Sunday School. The Circles meet for half an hour and allow the congregation time to take the sermon and reflect on the important messages within it and how we might apply them in our lives. It’s also a chance to share and help guests and new members feel connected in friendship with our community.

The Woman’s Circle plays a special role. In Jin Nim’s vision for this particular Circle is based upon her understanding of the central role of the “mother’s heart” in growing and developing our church. We need a church full of heart, tears, love and compassion; a church with deep faith, a church with the spirit of volunteerism and service. In this “age of women,” women need to take responsibility to nurture and build the strong presence of a “mother’s heart” in our congregations as a foundation for all of our collective efforts towards growth. The Woman’s Circle encourages women to bond in support of our Senior Pastor’s vision; making deep internal and external conditions to witness, nurture, and mentor everyone who comes to consider Lovin’ Life their church home.

Project Connect

What are small groups?

A small group is a voluntary group of people who have made it a priority to meet together on a regular basis. The number participating is kept small so that every member of the group can be engaged – can express themselves, participate, feel ownership of the group, and be held accountable by the group. A small group has a leader/facilitator and an assistant who work together for the well being of the group.

Whatever the specific activity of the group may be, the underlying purpose is to create an environment where members are able to put into practice the fundamentals of their faith; to inspire one another, care for one another, share God’s love and word with one another, and encourage one another to become contributors to the LLM.

2 types of groups

Connect Small Groups (PCSG) can be of two types, affinity and growth.

An affinity group is built around an activity that members have a passion for, something that they love to do. It could be a sport such as hiking, golf, or fishing. It could be an activity such as cooking, knitting, or painting, or it could be about something like parenting or learning a language – there is no limit.

A growth group focuses more around the spiritual development of the members and usually involves the study of inspirational materials. The material for study could be the DP, IJN’s sermons, the Bible, or any reading material (or film) that encourages discussion and activity that leads to spiritual growth. Many, when starting their first small group, used “One Anothering” by Richard Meyer, which is a book about how to do small groups.

As a general principle the mission of every PCSG is to – seek to advance the vision of the Lovin Life Ministry, “to inherit the true love of God,” by creating a place where every person is connected in heart and is able to experience the joy that comes through the practice of God’s love and truth.

For information on facilitator and small group training seminars in NY – contact Rev. Andrew Compton, Director of the PCSG Team in NY and NJ at comptonfamily@yahoo.com

A good web site for small group training is www.smallgrouptrader.com

To discuss issues and share testimonies involving small groups www.blessedfamilies.org has a “groups” button, then scroll down to “small groups” and join in.

CONTRIBUTE!

Contribute by Tithing

When we tithe, we offer our personal resources and trust God with that offering. The money we offer up should go to enhancing our ministry, which is expressed through Sunday Service, youth programs, education and empowerment programs, service projects and so much more. All these things help us bring our message to the world with EXCELLENCE. The more we give of our money, time and abilities, the more we will see our local churches flourish and thrive.

There is also a more internal aspect. Believe it or not, a lot of people have difficulties when it comes to tithing. I know it's crazy that people would be scared to offer up ten percent of their money, but it happens. We should start to understand that everything we have comes from our Heavenly Parent. With our tithe we are simply returning to God a very small portion of what God has given to us. The Bible says that if we are faithful with a little, then we can be trusted with more. It is through tithing that we learn to really trust and depend on God. We are giving up control and letting God open up new opportunities that would otherwise not be available. This helps us develop a more personal and deeper relationship with God, while making a difference in our communities.

Tithing Best Practices:

- Tithe with a cheerful heart
- Be happy that you can help CONTRIBUTE
- Stop looking at your financial situation with your physical eyes; they don't let you see what God has in store for you.
- Tithe consistently and persistently, you're not going to change your life style if you only tithe when it is convenient for you
- Know that God will always provide
- Realize that the "difference" is YOU. It's your choice and responsibility

Contribute by Volunteering

Church would not be possible without the efforts of volunteers. At Lovin' Life Ministries, we value our volunteers and actually encourage everyone to join a volunteer team that fits that person's interest. Volunteering is a great way to meet people in your community, have fun, and give back to your church. It's also the best way to take ownership of your church and to play a part in building something awesome for God's kingdom. There are many great ways to get involved from children's ministry, to music ministry, to outreach, to outreach. There is a team for everyone!



Who is a Volunteer at Lovin' Life Ministries?

A volunteer is a person who offers their unique abilities to enhance their church experience.

This definition is short and simple. Volunteering is not about sacrifice. It is not about giving up personal dreams or goals for the needs of the church. Volunteers at church may not receive monetary payment, but they do receive a community. Deciding to be a member at Lovin' Life Ministries is actually a decision to become a part of a family. If someone is a new member, then it is important for the older members to act as parents to the child, or an elder sibling to the younger, similar to a family dynamic. Eventually that child will grow and begin caring for the family as well. This is done through volunteering.

Volunteering is more than giving. It is more than serving. It is caring, owning and investing.

Need for this position

Because the church largely operates on volunteers, ensuring that they are efficiently utilized and positively recognized for their time and contribution will achieve greater results in the church programs and activities they serve. Volunteer opportunities require a combination of able hands, qualified minds, and passionate hearts. For example, there may be 25 able hands to provide the manpower to execute a task, but without competency or enthusiasm, the hands will not have a mind to tell them what to do, or a heart to tell them why what they are doing is important. The church is more than a building or a service; the church is a group of people who make up the Body. Without properly functioning organs, the body will suffer from malnutrition. The purpose of the Volunteer Coordinator is to be the skeleton which mobilizes volunteers to discover their potential as key components to the Body and to give them ownership to the community they serve. The Coordinator also provides them with a system that gives them the most satisfaction out of their contribution so that their efforts do not go unnoticed and that they are happy to volunteer for future needs.

For more information on how to run a successful volunteer program, contact Tami Gavin at tami@tamigavin.com

What our volunteers say

Volunteering is: full of friendship and fulfillment, fulfilling, Great, a blessing from God, challenging and good, Thrilling, rewarding, It's great!!!, fun, exciting, new awesome friends, Great!!, Joyful Growth, Very rewarding, Great! Amazing experience and amazing people, Very Good, a very wonderful experience, Exciting experience, Very rewarding and a wonderful way to serve others, Amazing and challenging at the same time, Truly, a blessing, memorable and educational, a growing experience, Fantastic, Great. Exciting, awesome, enjoyable, fulfilling, high-energy and rewarding, Great and a wonderful experience

Future Developments

We are working on, and will send more guidelines for the Circles, Sunday School, Membership Training Programs and Educational Programs.

